



GIANT[®]
BY TOBROCO



COMPACT DESIGN
BIG IN PERFORMANCE

G2300



WWW.TOBROCO-GIANT.COM

TECHNICAL DATA

TYPE	G2300 HD	G2300 X-TRA HD
Service weight ¹	2.300 kg	2.350 kg
Lifting capacity	1.650 kg	2.200 kg
Tipping load ²	1.595 kg	2.260 kg
DIMENSIONS AND SPEED		
Lifting height ²	2.825 mm	2.450 mm
Length without bucket	3.065 mm	3.145 mm
Machine height ³	2.300 mm	2.300 mm
Width on standard tyres	1.080 mm	1.080 mm
Standard tyres	10.0/75x15.3 AS	
Travel speed	0-10 km/h 0-20 km/h	
ENGINE		
	Kubota V1505 (STAGE V)	
Cylinders	4	
Engine power	26 HP / 19 kW	
Type	Diesel	
Fuel tank capacity	37 l	
Oil capacity	56 l	
POWERTRAIN		
Type	Hydrostatic 4 wheel drive	
Transmission	Automotive control	
Differential	Limited slip on both axles	
Final drive	8 tons axles (Heavy Duty)	
Pulling force	23.000 N	
Driving hydraulics	65 l/min (360 bar)	
Working hydraulics	32 l/min (210 bar)	
Parking brake	Drum brakes	

STANDARD OPTIONS

TYPE	G2300 HD	G2300 X-TRA HD
ROPS / FOPS safetyroof incl. safety doors left and right	Std	Std
Mechanically suspended seat incl. safety belt and armrest	Std	Std
Double acting valve at the front (mechanical)	Std	Std
Floating position on lifting cylinder(s)	Std	Std
Hydraulic servicebrake on 4 wheels	Std	Std
Working light (halogen) at the front	Std	Std
Main switch	Std	Std
Rear tow coupling	Std	Std
Cyclone filter	Std	Std
Oil cooler	Std	Std
GIANT Standard hydraulic quick change system	Std	Std

¹ Measured with earthbucket

² Measured with hinge point in straight position on standard tyres

³ Measured on standard tyres with safety roof

TIPPING LOADS

	G2300 HD	G2300 X-TRA HD
S	1.595 kg	2.260 kg
T	1.375 kg	1.740 kg
U	1.045 kg	1.255 kg
V	820 kg	935 kg
W	2.200 kg	2.945 kg
X	1.395 kg	1.750 kg
Y	1.100 kg	1.230 kg

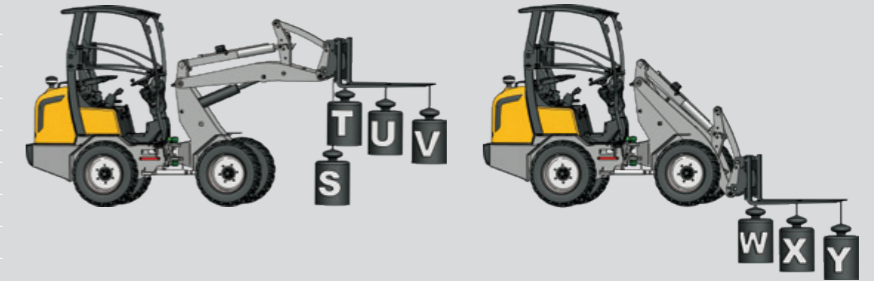

MEASUREMENTS

		Unit	G2300 HD	G2300 X-TRA HD
A	Wheelbase	mm	1.515	1.580
B	Total length	mm	3.065	3.145
C	Length with bucket	mm	3.690	3.830
D	Length 3 point hitch	mm	622	622
E	3 Point hitch in lowest position	mm	134	134
F	3 Point hitch in highest position	mm	797	797
G	Seat height	mm	1.256	1.256
H	Max. height with safety roof	mm	2.300	2.300
I	Max. height with cabin	mm	2.284	2.284
J	Height front frame	mm	1.480	1.250
K	Max. dumping height	mm	1.988	1.680
L	Lifting height	mm	2.825	2.450
M	Height with bucket	mm	3.392	3.040
N	Rollback angle on the ground	degrees	43	41
O	Rollback angle at max. lift height	degrees	53	46
P	Max. angle for bucket emptying	degrees	47	37
Q	Drive-up angle	degrees	29	29
R	Outer size of tires	ø mm	760	760
1D	Width on standard tyres	mm	1.080	1.080
1A	Turning radius with bucket	mm	2.599	2.650
1B	Turning radius on outer edge	mm	2.292	2.342
1C	Inner turning radius	mm	1.179	1.230

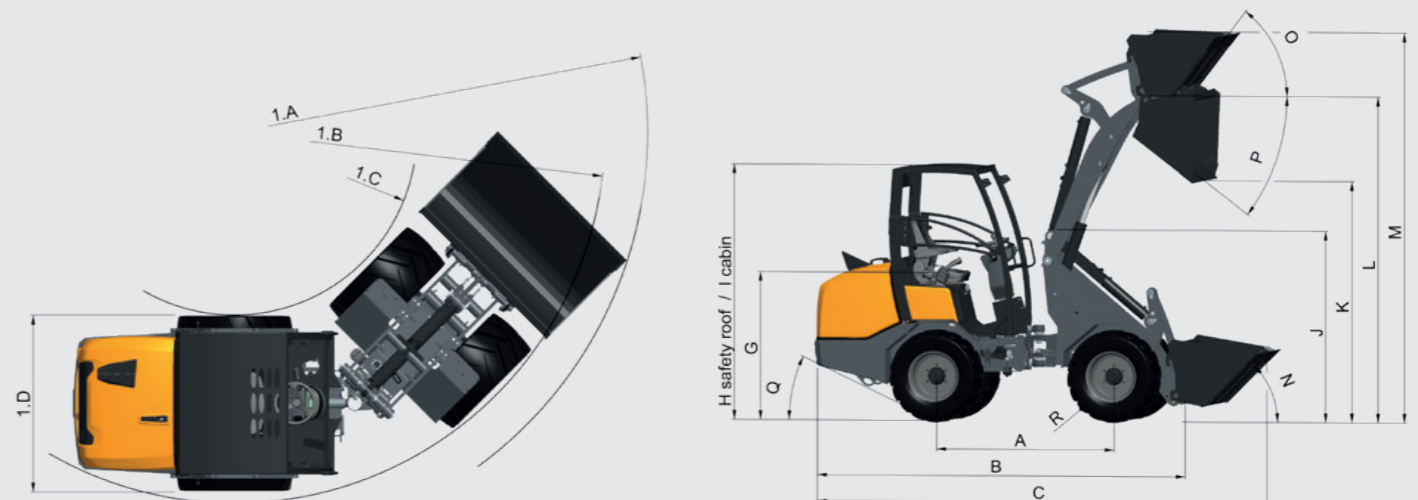

MODELS

TOBROCO-GIANT has been manufacturing quality GIANT machines and attachments since 1996 when we opened our first factory in the Netherlands. Today, TOBROCO-GIANT offers one of the broadest product portfolios in the business with 35 different models in 60 countries.

TOBROCO-GIANT supplies machines from 750 kg until 6.000 kg with engines from 20 hp till 76 hp for the worldwide machine market. Which machine will you choose?



SK212G
SK202D
SK252D



D204SW
D254SW



D204SW TELE
D254SW TELE



G1500
G1500 X-TRA



G2200 (X-TRA)
G2200 HD (X-TRA)
G2200 HD+ (X-TRA)



G2200E
G2200E X-TRA



G2300 HD
G2300 X-TRA HD



G2500 HD
G2500 X-TRA HD



G2700 HD (X-TRA)
G2700 HD+ (X-TRA)



G3500
G3500 X-TRA
G3500 TELE



G5000
G5000 X-TRA
G5000 TELE



GT5048

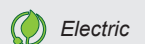

Electric



GIANT[®]
BY TOBROCO

TOBROCO-GIANT

Industrielaan 2
5061 KC Oisterwijk (The Netherlands)
Tel +31 (0)13-5211212
Fax: +31 (0)13-5234045
Internet: www.tobroco-giant.com
E-Mail: info@tobroco-giant.com

All technical data in this brochure refer to under Central European operating conditions tested series models and describe the standard functions. Specifications and their modes of operation, as well as accessories, depend on the model and the options of the product, as well as country-specific regulations in the country of sale. Images may show non-listed or non-standard available products. The descriptions, illustrations, weights and technical data are not binding and are in accordance with the state of the art at the time of going to press. Changes in the design, equipment, optics and technology are due to the continuous development of its products without prior notice. Do you need special functions which are only available through the use of additional components and / or under special circumstances, please contact us! We will be happy to answer your questions and let you know whether and under what conditions regarding the product and the environmental conditions special functions are realizable. When doubts about the capacity or the performance of our products under special circumstances, we recommend to perform under controlled conditions. Testing activities despite the utmost care, we cannot rule out deviations from illustrations or dimensions, calculation errors, misprints or omissions in this brochure. We therefore accept no liability for the correctness and completeness of the information contained in this brochure. As part of our General Terms and Conditions, we guarantee the proper functioning of our products. Furthermore Linear guarantees we provide in principle. A further liability than outlined in our Terms and Conditions is excluded.

